

Chaînes gamme F45

Chaînes acétal au pas de 12,7 mm

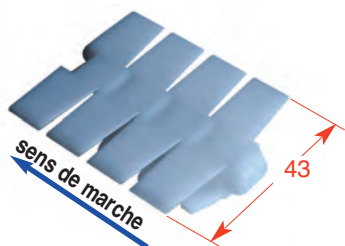
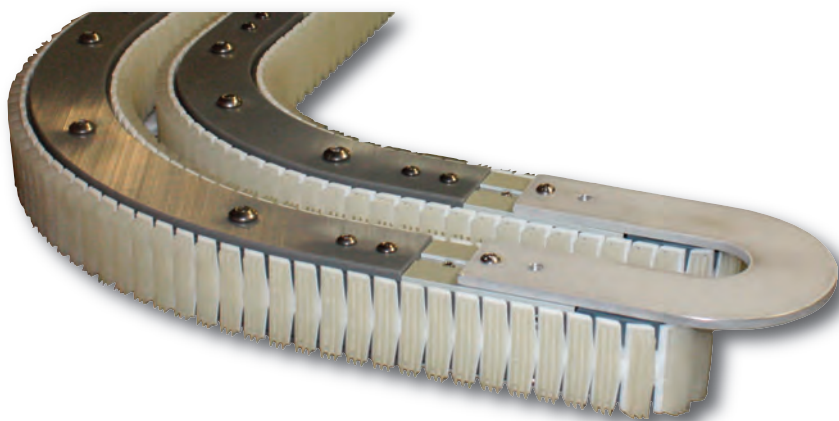
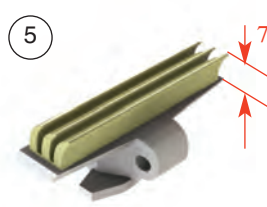
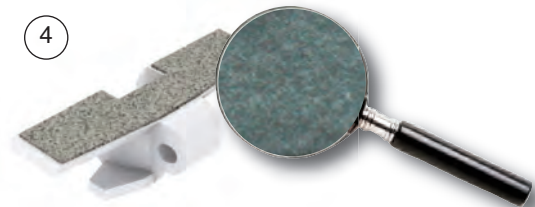

	Figure	
Chaîne plate acétal naturel	1	F45PC 3
Forme Vé à 140°	2	F45CV 3E
Chaîne avec insert	3	F45FT 3
Chaîne floquée	4	F45FC 3
Chaîne à lamelles	5	F45WT 3C



Limite élastique 200 N
Vitesse maxi 20m/mn
Conditionnement: rouleau de 3 m
Applications: produits légers
Longueur maxi du convoyeur : 6 m



Exemple d'application : cadenceur

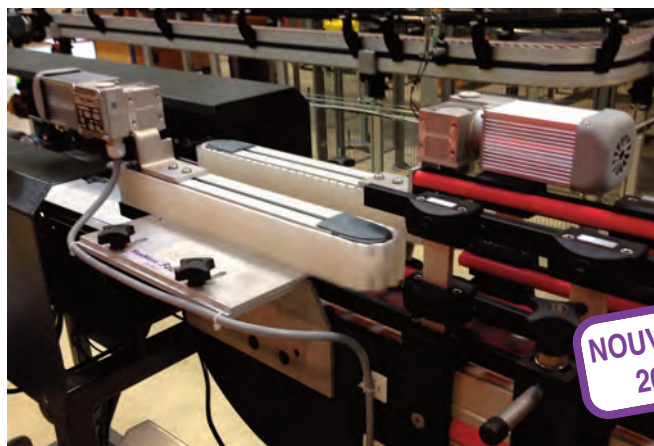

NOUVEAUTÉ
2017-1

Poutre F45CB

Conditionnement: barre de 3 m ;
(Recoupes à la demande)
Profil de glissement : **F45SR 25H** (PEHD+PA6 gris)

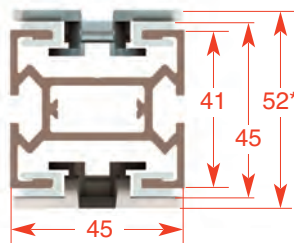
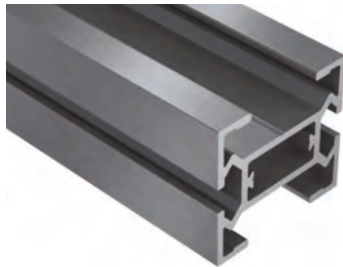

* avec chaîne F45 PC3

Modules d'entraînement

(utilisable arbre sortant à droite ou à gauche)
pignon 10 dents
Moteurs sur demande, vitesse maxi 20m/mn

ØA	Référence
9	F45DD 9
12	F45DD 12

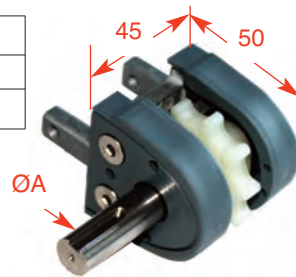

Montage standard

Montage avec moteur brushless



Module de renvoi F45IE 50

pignon 10 dents

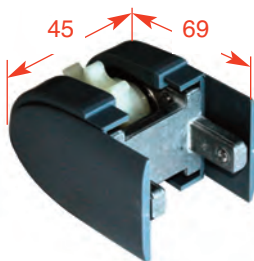

Courbes horizontales sur glissières

F45HB

Rayon moyen 150 ou 300 mm, parties droites de 40 mm, éclisses incluses

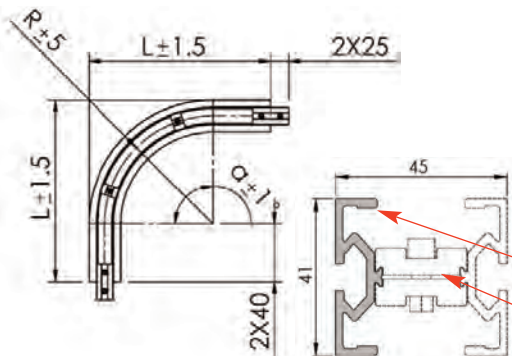

Demi-poutre F45CB 3H
Pince de fixation entre demi-poutres F45HB CLP

Module d'entraînement intermédiaire F45ID

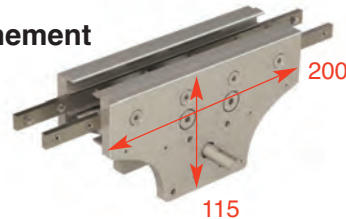

Courbes verticales sur glissières

F45VB

Rayon moyen 400 mm, parties droites de 40 mm, éclisses incluses



angle a	R = 150	R = 300
30°	F45HB 30R150	F45HB 30R300
45°	F45HB 45R150	F45HB 45R300
90°	F45HB 90R150	F45HB 90R300
180°	F45HB 180R150	F45HB 180R300

angle a	
5°	F45VB 5R400
7°	F45VB 7R400
15°	F45VB 15R400
90°	F45VB 90R400

Autres rayons sur demande

Eclisses

	figure	
latérale	1	FACS 11x100
centrale	2	FACS 50

①



②

